

U.S.SAWS™

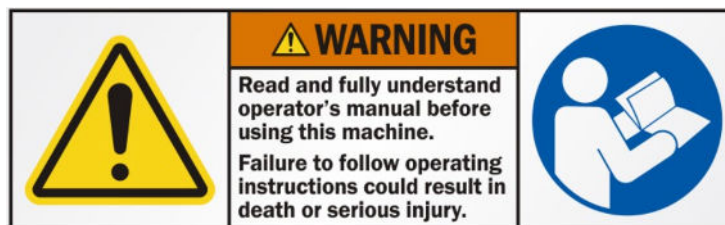

U.S.SAWS FSB-150 OPERATING MANUAL



Notice of Copyright Protection

Copyright 2020, by U.S.SAWS . All rights reserved. This work may not be reproduced or disseminated in whole or in part by any means without the prior written permission of U.S.SAWS

01-20-2021

U.S.SAWS™

**WATERWORKS
DIVISION**

P: 866-987-7297 F: 813-621-7125
Visit us at www.ussaws.com
sales@ussaws.com



INTRODUCTION & SPECIFICATIONS

1.0 INSTRUCTIONS FOR USE OF MANUAL SECTIONS

Section	Page
Table of Contents & Introduction	2
Symbols & Decals	3
Safety Instruction	4 - 5
Pre-Operation Checklist	6
Assembly & Operation	7
Parts Breakdown	8 - 9
Warranty & Service	10 - 11

Foreword/Introduction

The owner's manual is intended to point out some of the basic safety situations that may be encountered during the normal operation & maintenance of the U.S.SAWS FSB-150 Machine & to instruct you in safety practices for dealing with these conditions. Keep all manuals provided with your machine in a safe place at all times.

The information and specifications included in this publication were in effect at the time of approval for printing. U.S.SAWS reserves the right, however, to discontinue or change specifications or design at any time without notice and without incurring any obligation.

The FSB-150 walk-behind air saw is designed for simple operation and has been proven to be extremely useful and versatile. Up to a 20" diameter diamond blade may be mounted on the saw if it is rated and approved for operation at 3,300 RPM. READ, AND CAREFULLY FOLLOW THE OPERATING AND SAFETY INSTRUCTIONS OF THIS OPERATING AND SAFETY INSTRUCTION MANUAL BEFORE USING THIS PRODUCT. Since safety regulations can vary between different countries and states, you must contact proper authorities and follow all appropriate regulations



DANGER: Indicates an imminently hazardous situation that if not avoided, will result in death or serious injury. This signal word is limited to the most extreme situations.



WARNING: Indicates a potentially hazardous situation that, if not avoided, could result in death or serious injury.



CAUTION: Indicates a potentially hazardous situation that, if not avoided may result in minor or moderate injury. It may also be used to alert against unsafe practices that may cause property damage.

2.0 SPECIFICATIONS

Model	FSB-150
Part Number	US60050
Power Source	Gear Box
Air Requirements	min 90 cfm @ 90 psi
RPM	3,300
Max Cutting Depth	7.5"
Dia. Blades Used	20" Maximum
Weight	144 lbs



Read this entire operations and maintenance manual before using your new tool. Pay close attention to the Rules for safer operation,

Dangers, Warnings and Cautions.

The purpose of safety symbols and explanations are to attract your attention to possible hazards and how to avoid them. The safety symbols and explanations do not by themselves eliminate any danger. The instructions or warnings they give are not substitutes for proper accident prevention measures.



SYMBOLS & DECALS

3.0 SYMBOLS & DECALS

For Safe Operation

You must be qualified for safe operation of the U.S.SAWS FSB-150 walk behind machine. You must clearly understand the written instructions supplied by U.S.SAWS, be trained - including actual operation - & know the safety rules & regulations for the job site. It is a safety practice to point out & explain safety signs & practices to others & to make sure they understand the importance of following these instructions.

Be Safe

Human error is the result of many factors: carelessness, fatigue, sensory overload, preoccupation, unfamiliarity with the machine or attachments, or drugs or alcohol, to name a few. You can avoid serious injury or death caused by these & other unsafe work practices. Be safe and never assume accidents cannot happen to you.

For your safety and the safety of others, act safely and encourage your fellow workers to act safely as well.



Read and understand operator's manual before using this machine. Failure to follow operating Instructions could result in injury or damage to equipment.



Use only diamond blades (steel centered diamond cutting-off wheels) with this machine. RPM rating on blade must exceed machine max rpm rating. The use of any other blade could result in death or serious injury.

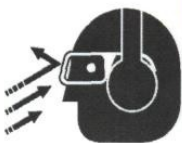

Flying debris and loud noise hazards. Wear ear and eye protection



Exhaust contains poisonous carbon monoxide gas. Breathing it could cause death. Operate machine in well ventilated area.



AVOID INJURY.

Do NOT operate with guard removed. Replace guard before operating machine.



Wear safety boots when operating this machine



Wear appropriate clothing



Wear Head Protection, breathing protection, and the use of hearing protection is mandatory



Wear hand protection



Wear proper electrostatic grounding equipment at all times. Static discharge during fueling can cause explosion

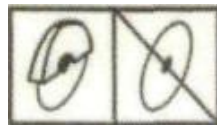

Keep all guards in place



Rotating blade hazard. Keep hands and feet away.



TO AVOID INJURY.

Always inspect saw blades before use. Replace all cracked or damaged blades.



SAFETY INSTRUCTIONS

4.0 SAFETY INSTRUCTIONS

4.1 KNOW THE RULES & YOUR EQUIPMENT.

Most job sites have rules governing equipment use & maintenance. Before starting at a new work location, check with the supervisor or safety coordinator. Ask about any rules or regulations you need to abide.

OSHA enforces federal laws within the United States that apply to the safe operation, application, & maintenance of equipment on job sites. It is the employer's responsibility to comply with these laws.

Do not operate this machine unless you have read the operations and maintenance manual carefully.

4.2 RECEIVE PROPER TRAINING.

Do not operate this machine unless you have received operational and maintenance training from a U.S.SAWS representative or from an authorized distributor for U.S.SAWS.

4.3 PROTECT YOUR FEET.

Observe all applicable local, state and federal safety regulations. Wear OSHA approved foot protection.

4.4 PROTECT YOUR EYES.

Observe all applicable local, state and federal safety regulations. Wear OSHA approved safety glasses.

4.5 PROTECT YOUR LUNGS.

Breathable silica may be generated by use of this product. Silica can cause severe and permanent lung damage, cancer, and other serious diseases. Do not breathe the dust. Do not rely on your sight or smell to determine if the dust is in the air. Silica may be in the air without a visible dust cloud. If air monitoring equipment for silica is not provided by your employer at your work site, you **MUST** wear appropriate respiratory protection when using or servicing the machine. Consult your employer and OSHA regarding the appropriate respiratory protection.

4.6 PROTECT YOUR HEARING.

Observe all applicable local, state and federal safety regulations. Wear OSHA approved hearing protection.

4.7 DRESS PROPERLY.

Do not wear loose clothing or jewelry that can be caught in moving parts. Wear protective hair covering to contain long hair. Keep hair away from motor air vent. Rubber gloves and non-skid footwear are recommended when working outdoors.

4.8 AVOID A DANGEROUS ENVIRONMENT.

Do not expose machine to rain. Do not use machine in wet conditions. Water entering a power tool will increase the risk of electric shock. Keep work area well lit. When working at an elevated location, pay attention to articles and persons below. If operating the power tool in damp locations is unavoidable, use a Ground Fault Circuit Interrupter (GFCI) protected supply. Use of an GFCI reduce the risk of electric shock.

4.9 AVOID ANY AREAS OR ACTIONS THAT EXPOSE YOU TO CARBON MONOXIDE.

Do not operate in areas where exhaust fumes could accumulate without wearing appropriate respiratory protection. Consult your employer and OSHA regarding use of appropriate respirator for dangerous carbon monoxide gases.

4.10 KEEP WORK AREA CLEAN. DO NOT RUN OVER ANYTHING.

Loose objects could be thrown from crack. Make sure area to be cut is clear from people and any loose objects, nuts, bolts, etc. Never run over any loose objects.

4.11 KEEP CHILDREN AND VISITORS AWAY.

Do not allow anyone to stand in line with the blade path. Do not let children or visitors contact machine or extension cord. Keep children and visitors away from the work area.

4.12 KEEP FIRM GRIP ON MACHINE.

During normal operation as instructed in Section 6.0, keep a firm hold on the handle grips and maintain control of the machine until the blade completely stops.

4.13 SHUT OFF MACHINE.

When not in use, before servicing and when changing accessories shut off motor. Release the lever switch and move the on/off switch to the OFF position. Move the fuel valve lever to the OFF position.

4.14 STORE IDLE EQUIPMENT.

The machine and tools should be stored in a dry and secure location when not in use. Keep equipment out of reach of children.

4.15 OBTAIN MATERIAL SAFETY DATA SHEET (MSDS) FOR ALL WORK SURFACE MATERIALS.

This includes primers, all coatings, adhesives, tile and crack filling materials, etc. Do not attempt to cut, clean out or remove material without MSDS information. Consult MSDS sheet for hazards information. Be aware that some materials are explosive as a dust.

4.16 DO NOT OVERREACH.

Keep proper footing and balance at all times.

4.17 MAINTAIN MACHINE WITH CARE.

Keep machine clean and follow maintenance procedures for better and safer performance. Keep handles dry, clean, and free from oil and grease. Follow instructions for lubricating and changing accessories.

4.18 REMOVE ADJUSTING TOOLS.

Form a habit of checking to see that tools such as adjusting wrenches are removed from the machine and properly stored before starting the motor.

4.19 STAY ALERT.

Watch what you are doing. Use common sense. Do not operate machine when you are tired or fatigued.



SAFETY INSTRUCTIONS

4.20 DO NOT USE DRUGS, ALCOHOL, MEDICATION.

Do not operate machine while under the influence of drugs, alcohol, or any medication.

4.21 KEEP THE RIGHT PARTS IN THE RIGHT POSITIONS.

Do not operate machine with parts missing or improperly mounted.

4.22 CHECK DAMAGED PARTS.

Verify all parts are in good condition and will function properly before using the machine. Check for alignment of moving parts, binding of moving parts, breakage of parts, mounting, and any other conditions that may affect machine operation. Do not operate machine if lever or motor on/off switch does not function properly.

4.23 SECURELY MOUNT ACCESSORIES TO THE MACHINE.

Extra care must be taken in an elevated location to prevent injury to someone on a lower level in the event the tool or accessory should drop. Do not operate without fall protection for operator and debris protection for public.

4.24 NEVER TOUCH THE MOVING PARTS.

Never touch moving parts such as blades, belts and others.

4.25 STOP OPERATION IMMEDIATELY IF ANY ABNORMALITY IS DETECTED.

Stop using machine immediately if any abnormalities are observed during operation. Examples of abnormalities include unusual noise and vibration.

4.26 WHEN REPLACING A PART, USE THE SAME TYPE AND QUALITY.

When replacing a component part with a new one, use only the same type and quality of new part. Never attempt to repair a machine if you are unfamiliar with proper procedures and techniques required.

4.27 LOAD AND UNLOAD SAFELY.

Use proper heavy lifting procedures. Read & understand manuals before loading & unloading.

4.28 SAVE THESE INSTRUCTIONS.

Refer to this operations and maintenance manual as well as any additional instructions included from other manufacturers and organizations such as the Masonry and Concrete Saw Manufacturers Institute®. Never permit anyone to operate the machine without proper instructions.

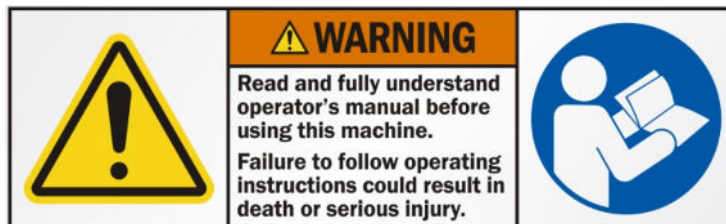

DUST WARNING

Cutting, especially when DRY cutting, generates dust that comes from the material being cut, which frequently contains silica.

Silica is a basic component of sand, quartz, brick clay, granite and numerous other minerals and rocks. Exposure to excessive amount of such dust can cause:

- Respiratory diseases (affecting your ability to breath), including chronic bronchitis, silicosis and pulmonary fibrosis from exposure to silica. These diseases may be fatal;
 - Skin irritation and rash; and
 - Cancer according to NTP* and IARC*
- * National Toxicology Program, International Agency for Research on Cancer

Take precautionary steps

- Avoid inhalation of and skin contact with dust, mist and fumes;
- Wet cut when feasible, to minimize dust;
- Wear and ensure that all bystanders wear appropriate respiratory protection such as dust masks designed to filter out microscopic particles. (See OSHA 29 CFR Part 1910.1200)

California Prop 65 Warning: Use of this product can cause exposure to materials known to the State of California to cause cancer and/or birth defects or other reproductive harm.



PRE-OPERATION CHECKLIST

5.0 PRE-OPERATION CHECKLIST



Read and understand operator's manual before using this machine. Failure to follow operating instructions could result in injury or damage to equipment.

Figure 1 - Warning label - read and understand manual

5.1 Start by reading the entire Owner's Manual, Rx for Diamond Blade Safety, and Rx for Concrete Saws by the Masonry and Concrete Saw Manufacturers Institute. Then, read the entire FSB-150 operations and maintenance manual. Get familiar with the machine's parts.

TO PREVENT SERIOUS INJURY DO NOT OPERATE SAW WITHOUT PROPER TRAINING AND UNDERSTANDING OF THE OWNERS MANUAL WHEN OPERATING THIS MACHINE



Keep all guards in place



Wear Head Protection, breathing protection, and the use of hearing protection is mandatory

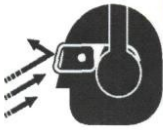

Flying debris and loud noise hazards. Wear ear and eye protection



Wear hand protection



Rotating blade hazard. Do NOT operate with guard up. Keep hands and feet away.



WARNING: Improperly maintaining the FSB-150 failing to correct a problem before operation could cause a malfunction resulting in a serious injury. Always perform a pre-operation inspection before each operation and correct any problem.

5.2 Observe the condition of your work environment. Walk over area work area and look for hazards. Make sure the work environment is safe and meets all safe-working conditions discussed in section 4, Rules for safer operation.

5.3 Check for missing or loose bolts. Tighten loose bolts and replace missing bolts before operating machine.

5.4 Dress properly. Wear ear and eye protection.

5.5 Obtain SAFETY DATA SHEET (SDS) for all work surface materials. This includes primers, all coatings, adhesives, tile and crack filling materials, etc. Do not attempt to cut, clean out, or remove material without SDS information. Consult SDS sheet for health hazards information.



WARNING: The U.S.SAWS FSB-150 maximum blade operating speed is 3300 rpm. Do not use a blade that is not a dry cut diamond blade. Using a non dry cut diamond blade or a blade rated below 3300 rpm could result in severe blade failure, personal injury or death. Never cut material for which the blade was not designed. Check blade manufacturer's guidelines on material to be cut. Never operate a blade in the wrong rotation direction. Verify blade direction when changing blades. The U.S.SAWS FSB-150 is designed to cut in a straight line. Never attempt to cut any pattern or follow any joint that is not a straight line.

3,300 MAX. RPM

Figure 2 - Max rpm label - maximum blade speed

5.6 Choose the proper dry cut diamond blade for the application, speed and material to be cut.



Use only diamond blades (steel centered diamond cutting-off wheels) with this machine. RPM rating on blade must exceed machine max rpm rating. The use of any other blade could result in death or serious injury.

Figure 3 - Warning label - use only diamond blades

5.7 Clearly mark all intended cut areas with straight paint or chalk lines.



CAUTION: Running the FSB-150 generates heat in the motor, blade. Do not touch these components without wearing proper heat protecting work gloves.



WARNING: Breathable silica may be generated by use of this product. Silica can cause severe and permanent lung damage, cancer, and other serious diseases. Do not breath the dust. Do not rely on your sight or smell to determine if the dust is in the air. Silica may be in the air without a visible dust cloud. If air monitoring equipment for silica is not provided by your employer at your work site, you MUST wear appropriate respiratory protection when using or servicing the machine. Consult your employer and OSHA regarding the appropriate respiratory protection.



ASSEMBLY & OPERATION

6.0 OPERATIONS

6.1 ASSEMBLY OF WATER TANK KIT

6.1.1 Attach the water tank frame to the saw's chassis by sliding the frame from the front towards the back. A 3" bolt will secure the top back of the frame to the handle quadrant and two 5/16" bolts will attach the front leg of the frame to the front of the chassis.

6.1.2 Mount the plastic water tank to the frame and secure it with 4 bolts. Attach one end of the water feed hose with the control valve to the bottom of the water tank. The end with the "Y" should be attached to the two 1/2" clear plastic tubings.

6.2 ASSEMBLY INSTRUCTIONS

6.2.1 For shipping convenience, your saw (FSB-150) may have been shipped without the Handle Assembly, Jack Assembly and Pointer attached.

6.2.2 **INSTALL THE JACK ASSEMBLY:** Release the 2 3/4" bolt on the jack bracket from the saw chassis and the center bolt on the handle quadrant. Rotate the crank on the jack assembly counterclockwise so that the two pivot tubes line up with the nut on the jack bracket and the holes of the center bolt. Notice that the upper pivot tube has to face down and the lower pivot tube has to face up. First, insert the center bolt through the handle quadrant plates and the jack's upper tube and tighten it. Then, insert and tighten the bolt on the jack bracket through the lower pivot tube until the bolt goes through the hole on the chassis.

6.2.3 **INSTALL HANDLE ON THE HANDLE QUADRANT:** Attach bar grip to handle assembly. Adjust the water valve to a 45 degree position by loosening the bolt and adjusting the water valve bracket with the 45 degree cut parallel to the handle, tighten the bolt. Pull out the knob's bolt and the edge bolt on the handle quadrant. Slide the handle assembly between the two plates of the handle quadrant so that the two handle pivot tubes line up with holes of the knob's bolt and edge bolt. Bolt them up. Attach the longer air hose on the handle assembly to the oiler on the saw.

6.2.4 **INSTALL THE POINTER ON THE SAW:** Pull out the 2 1/2" bolt on the pointer base bracket. Place the pointer base bracket at the hole on the chassis in front of the motor which is parallel to the chassis base. Insert the bolt all the way through the blade guard and tighten up.

6.2.5 **INSTALL OR REPLACE BLADE:** Disconnect air supply. Remove arbor nut (left-hand threads) and outer flange from shaft. Place blade on shaft and check that the directional arrow points clockwise (counterclockwise on upcut saws) as you turn the shaft. Install outer flange and hand tighten arbor nut (left-hand thread). Hold inner flange with supplied 2" wrench and tighten the arbor nut using 1" or 1 1/2" wrench supplied.

6.3 BEFORE OPERATING THE SAW

6.3.1 Be sure all nuts and bolts are tight.

6.3.2 Check the air supply for the correct pressure (90 PSI Min) and rating (85 CFM Min).

6.3.3 Turn on air supply and check for leaks

6.3.4 Be sure to clean air hose to discharge any dirt, scale or moisture (and do so before each use).

6.3.5 Connect the air hose and ensure proper couplings are used on air lines - typically no fitting is smaller than 1/2". Ensure the in-line oiler is filled with pneumatic ice free oil.

6.4 WHILE OPERATING THE SAW

6.4.1 Before entering the blade into the material to be cut, squeeze the trigger and allow the saw to reach full speed.

6.4.2 Ease the saw blade into the material to be cut.

6.4.3 At the end of the cut, lift the saw until the blade is clear of the cut, then release the trigger.

6.4.4 Allow the blade to come to a complete stop before setting it down.

6.4.5 Check the in-line oiler for oil level after 2-3 hours of operation.

6.5 AFTER OPERATING THE SAW

6.5.1 Shut off air supply and disconnect from saw.

6.5.2 Remove the air line and fit a protective cover over the air inlet.

6.5.3 Clean the saw by removing all accumulated dust.

6.5.4 Give the grease fitting a couple shots of grease after every 40 hours of operation.(gearbox saw only).

6.5.5 Pour a small amount of general purpose air tool oil into other hose connector on the handle to flush out any moisture and lubricate the motor.

6.6 INSTALLING OR REPLACING BLADE

6.6.1 Turn off and Disconnect air supply and remove arbor nut (left-hand thread) and outer flange from shaft

6.6.2 Place blade on shaft and check that the directional arrow points clockwise as you turn the shaft (counterclockwise on up cut saws)

6.6.3 Install outer flange and lock gearbox with lock pin button under gearbox. Tighten arbor bolt with wrench provided. Release gearbox lock and spin blade to inspect blade rotation is smooth and straight.



PARTS BREAKDOWN

7.0 FSB-150 Parts Breakdown

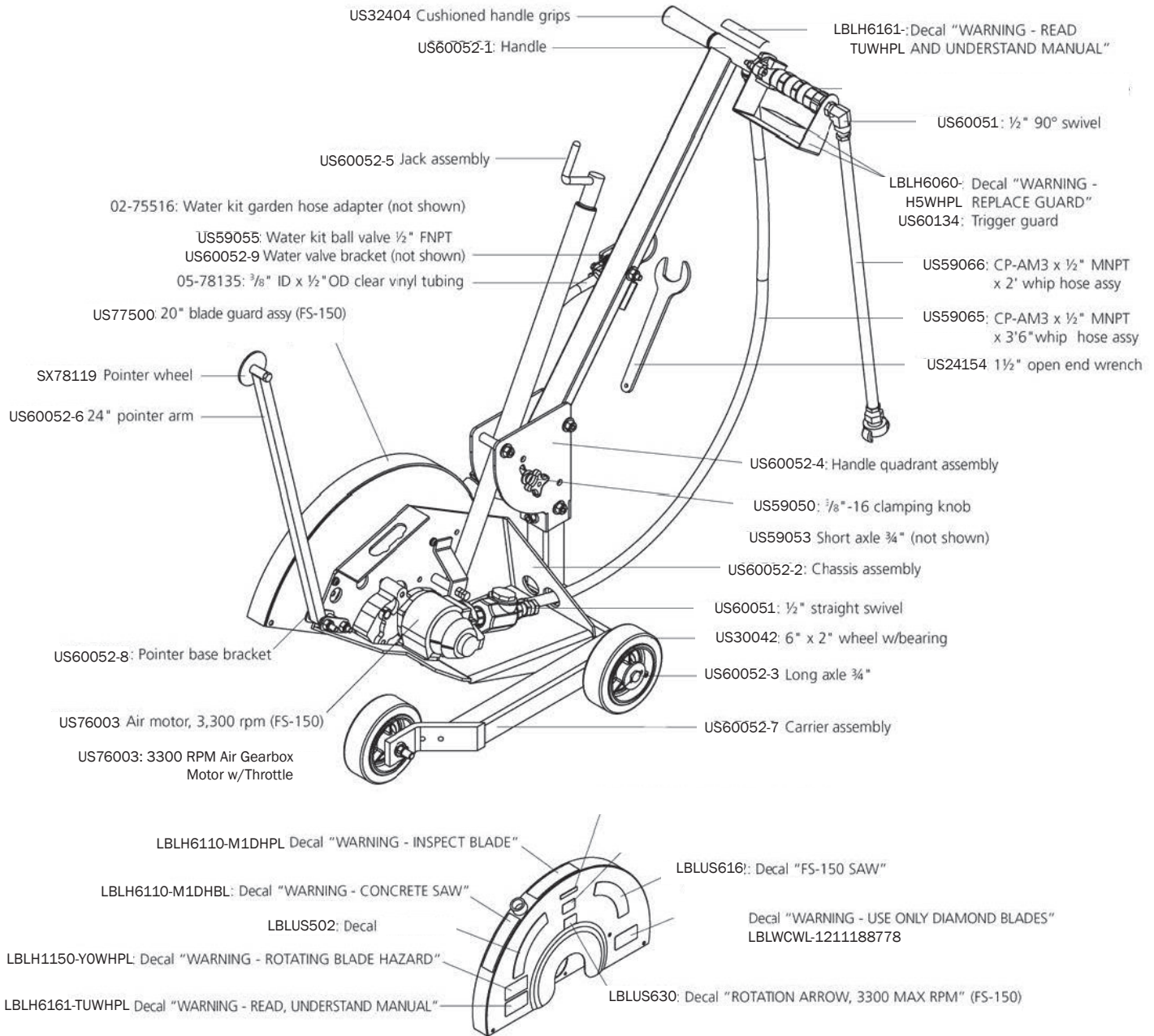

Model	Part Number	Description
FSB-150	US60050	Walk-behind air powered saw with gear box motor, 20" blade capacity, water feed kit, whip hose, oiler, wrenches, and one quarter ice free air oil. 3,300 RPM saw cuts to 8" depth.
Air Tool Oil	02-17059	(1) Quart of petroleum based ice free oil
Oiler	US15060	#5 - PF, 1/2" NPT



PARTS BREAKDOWN

3,300 RPM Air Motor US76003

Items in bold below (bearing sleeve, bearing and large end plate) can be purchased as an upgrade kit (part no. 02-70116A) for saw models prior to serial number UU-0981.

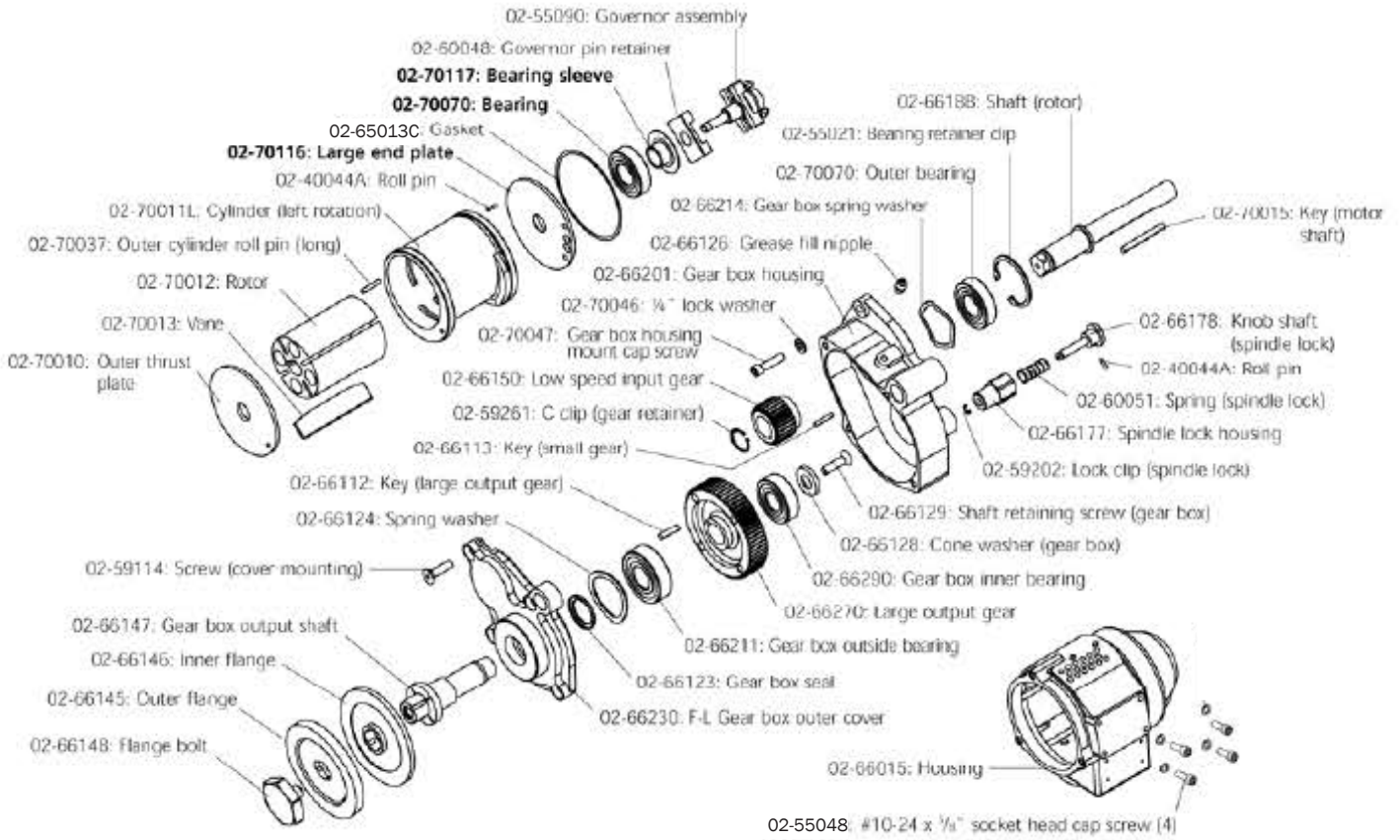

WARRANTY AND SERVICE

8.0 WARRANTY AND SERVICE

8.1.1 Warranty

This document is to be used as a guide in determining warranty policies and procedures for U.S.SAWS and its U.S.SAWS products. It is to be used in determining whether a warranty is justified and as a procedural guide in completing a U.S.SAWS warranty claim form.

8.1.2 Warranty Responsibility

The distributor or the end user must prepare a Machine Warranty Information Card when the machine is delivered. Failure to comply will make any and all warranties on this equipment null and void. Credit for warranty repairs will be given only after receipt of the WARRANTY CLAIM FORM, properly completed with all the required details. Submittal details are described later in this document.

8.1.3 Warranty Policy

8.1.3.1 U.S.SAWS warrants its U.S.SAWS products against defects in material and workmanship under normal and proper use for a period of one year (365) days from the date of delivery; in the case of Rental Fleet Machines, date of assignment to Rental Fleet. Such warranty is extended only to the buyer who purchases the equipment directly from U.S.SAWS or its authorized distributor. This warranty does not include expendable parts such as, but not limited to, plugs, cutters, blades, blast wheel, wear parts, liners and seals.

8.1.3.2 The obligation under this warranty is strictly limited to the replacement or repair, at U.S.SAWS' option, of machines and does not include the cost of transportation, loss of operating time, or normal maintenance services.

8.1.3.3 This warranty does not apply to failure occurring as a result of abuse, misuse, negligence, corrosion, erosion, normal wear and tear, alterations or modifications made to the machine without express written consent of U.S.SAWS .

8.1.3.4 Warranty request must be submitted in writing within thirty (30) days after failure.

8.1.3.5 Written authorization to return merchandise under warranty must first be obtained from U.S.SAWS .

8.1.3.6 U.S.SAWS reserves the right to inspect and make the final decision on any merchandise returned under warranty.

8.1.3.7 U.S.SAWS offers no warranty with respect to accessories, including but not limited to, engines, motors, batteries, electrical boards, tires and any other parts not manufactured by us but which the original manufacturer warrants.

8.1.3.8 U.S.SAWS reserves the right to make product changes or improvements without prior notice and without imposing any obligation upon itself to install the same on its products previously sold.

8.1.3.9 The above warranty conditions can only be altered by U.S.SAWS. U.S.SAWS must confirm alterations in writing for each specific transaction.

8.1.3.10 U.S.SAWS reserves the right to establish specific warranty terms for used or demo machines on an individual transaction basis. Invoices covering such merchandise will clearly state the provisions of the applicable warranty for each specific transaction.

8.1.3.11 WE DO NOT AUTHORIZE ANY PERSON, REPRESENTATIVE OR SERVICE OR SALES ORGANIZATION TO MAKE ANY OTHER WARRANTY OR TO ASSUME FOR US ANY LIABILITY IN CONNECTION WITH THE SALE OF OUR PRODUCTS OTHER THAN THOSE CONTAINED HEREIN.

8.1.3.12 UNDER NO CIRCUMSTANCES SHALL US SAWS BE LIABLE TO CUSTOMER OR ANY OTHER PERSON FOR ANY DIRECT, INCIDENTAL, OR CONSEQUENTIAL DAMAGES RESULTING FROM THE USE OF THE PRODUCT OR ARISING OUT OF ANY BREACH OF ANY WARRANTY OR FOR ANY SPECIAL OR CONSEQUENTIAL DAMAGES OF ANY CHARACTER, INCLUDING WITHOUT LIMITATIONS, DAMAGES FOR ANY LOSS OF GOODWILL, WORK STOPPAGE, OR ANY AND ALL OTHER COMMERCIAL DAMAGES OR LOSSES.

8.1.3.13 U.S.SAWS MAKES NO OTHER WARRANTIES, EXPRESSED OR IMPLIED, INCLUDING, BUT NOT LIMITED TO, THE IMPLIED WARRANTIES OF MERCHANTABILITY AND FITNESS FOR A PARTICULAR PURPOSE WITH RESPECT TO THE U.S.SAWS PRODUCTS SOLD PURSUANT THERETO.



MACHINE WARRANTY INFORMATION CARD

TO ENSURE THE PROPER WARRANTY COVERAGE IS EXTENDED TO THE OWNER OF THIS MACHINE, FILL OUT THE ATTACHED CARD COMPLETELY AND ACCURATELY.

WARRANTY REGISTRATION CARD

IMPORTANT! To ensure that your U.S.SAWS machine is covered under warranty, please fill in the following information and mail or fax it to U.S.SAWS, 8004B E. Broadway Ave. Tampa, FL 33619, Fax No. 714-434-7299

COMPANY
NAME
ADDRESS
INTENDED USE
DATE OF PURCHASE
INTENDED USE
SERIAL NUMBER

If you are not the owner of record as shown on the manual copy of the warranty registration card, do not operate this machine before contacting U.S.SAWS at 1-866-987-7297 Verify the following before operating the equipment:

CHANGE OF OWNER OR NEW ADDRESS REGISTRATION CARD

IMPORTANT! To ensure that your U.S.SAWS machine is covered under warranty, please fill in the following information and mail or fax it to U.S.SAWS, 8004B E. Broadway Ave. Tampa, FL 33619, Fax No. 714-434-7299

COMPANY
NAME
ADDRESS
INTENDED USE
DATE OF PURCHASE
INTENDED USE
SERIAL NUMBER

12

